

EUROPE CATALOG

CRESCENT
garden



About Us	04
Catalog and Program Details	10



TruDrop One Self-Watering Planters 16

Cup Tall Planters	28
Dot Planters	30
Mod Family of Planters	34
Nest Planters	40
Pinch Planters	46
Rim Planters	50
NEW Slat Planters	56
NEW Slat Window Boxes	58
TruDrop One - Add-ons for Pinch and Slate Planters	60
TruDrop One - Easy Drain System	63
Replacement Parts for TruDrop Planters	65



10 Year Warranty Planters 90

Brunello Rolled-Rim Planters	100
Delano Planters	102
Delano Oval Bowls	104
Delano Tall Planter	106
Eye Planters	110
Fold Planters	112
Madison Planters	116
Origami Planters	120
Pleat Planters	126
Ridge Planters	128
Step Planters	130

Circular Positive Planters 66



TruDrop Flex Self-Watering Planters 68

NEW (+) Fold Planters	74
NEW (+) Ridge Planters	76
NEW (+) Step Planters	80
NEW (+) TruDrop Flex - Insert and Water Gauge	82



Everyday Planters 84

(+) Emma Planters	86
-------------------------	----



Mobility and Drainage Solutions 132

Pebble Plant Caddies	136
Universal Round and Square Saucers	140



Marketing Aids 146

Digital Opportunities	148
Garden Center Signage	150
Color Sample Pack	150
Crescent Garden Display Platforms	151
TruDrop POP Material	152



Our Customer Promise

When Paula Douer and Harry Tchira created Crescent Garden in 1999, they were skilled in manufacturing and design, and while enthusiastic about gardening they weren't yet experts. They set about listening, learning, and discovering from industry friends and colleagues what's needed for gardens and gardeners to thrive. 25 years later, the Crescent Garden Company is a popular and progressive home and garden provider, bringing together a premier container gardening brand, a pioneer in self-watering and sustainable solutions. The company culture is powered by people who are professional, passionate and always in their customers' corner.

Lead brand Crescent Garden, trusted by contractors, designers, plant experts, independent garden centers and nurseries, offers containers and accessories distinguished by refined design and breakthrough innovation that lasts and lasts, for successful, inspired gardening.

Their pioneering TruDrop™ system engineers self-watering planters to go up to weeks without watering, for phenomenal results and more confident gardeners. TruDrop dramatically transforms the way people care for plants.

Crescent Too, available across garden centers, popular retailers and online, brings attractive and useful containers and supplies that make gardening easier and more rewarding to more people, at excellent value.

Crescent Garden believes that planters should work for you, not the other way around, and directs their R&D on design and innovation that pushes the envelope, legendary reliability and durability in whatever season, and understanding what works best for healthy plants and the people who love them.

With a vision to make gardening more accessible and relevant to everyone, while going beyond industry standards for what's possible, the Crescent Garden Company dedicates everything toward a simple customer promise:

we help you grow

CRESCENT *garden*

Crescent Garden planters are defined by their refined design and breakthrough innovation that lasts and lasts for successful, inspired gardening.



All encompassing TruDrop
One self-watering



Inspired solutions with
design in mind



Timeless design



Trend-setting style

Crescent**TOO**

Attractive and useful planters that make gardening easier and more rewarding for more people.



Versatile self-watering with TruDrop Flex



Best-selling Circular Positive Emma planters made with UBQ™

At Crescent Garden, sustainability begins with a distinct sensibility — a circular, continuous approach for positive impact wherever we can make a difference. We look at everything in harmony, inside and out, over time.

Surrounding our products are processes and policies, for a holistic approach to lessening our own environmental footprint, which in turn can result in more climate-positive outcomes in our retailer and customer communities.

Whether it's internal ways of working, how we source, make and distribute, or how gardeners use, dispose, and recycle, we want to help everyone grow, more sustainably.

Centered on the lifecycle of our products

Our R&D lifecycle is circular from the outset: Materials / Manufacturing / Distribution / Customer Experience. Thoughtful resource use and innovations in product development, energy-efficient manufacturing, reducing our shipping carbon footprint, ecological emphasis in product use and advice, and responsible disposal and reuse. Good goes around.

Promoting green spaces in our facilities.

Our manufacturing facility in Colombia sits on a campus that invested heavily in adding trees and green spaces where there weren't any before, for improved carbon offset. Our new corporate headquarters that will open in 2025, is designed as a multi-use space with large green areas both indoors and outdoors that are designed as flexible work spaces both for us and open to the public.

Creating a paperless company

From our beginnings over 25 years ago, we envisioned a nature-centric company that would use technology to remain paperless. We have no file cabinets, and our team members work together on multiple, energy-efficient screens, integrating electronically with our vendors and customers. We continue to pioneer ways to work more resource-efficiently throughout.



DESIGN & PRODUCTION

- Responsible manufacturing is fundamental: efficient, safe, environment-conscious, and community-minded.
- Total Recycling approach reusing scrap and excess in our own facilities.
- Use of local, renewable suppliers when available.



100% MATERIALS

- Designed for continuous use – never ending the lifecycle.
- 100% recyclable across multiple lifecycles.
- Easily separated mixed materials.
- **Introducing** upcycled and bio-based innovations: **Circular Positive™** product ranges.



DISTRIBUTION

- Lightweight and unbreakable products that use less energy and packaging in transport.
- Ordering, production and shipping procedures to minimize resource consumption.



CONSUMER EXPERIENCE

- Using less water and fertilizer, a vital element in sustainable gardens.
- TruDrop self-watering planters collect rain and irrigation water for up to 50% savings.
- High durability. Most products supported by a 10 Yr Warranty.

Specifications on Product

dimensions		
7.75 in 19.7 cm	11.75 in 29.8 cm	11 in 27.9 cm

We have included inner and outer measurements as well as volume capacity for all our planters to make it easy when specifying a planter for a job.

	dimensions				volume capacity	planter ref.#	saucer ref.#
A Agave 18" Planter	12.75 in 34.3 cm	7.75 in 19.7 cm	11.75 in 29.8 cm	11.00 in 27.9 cm	4.50 gal 15.8 l	A8800XX	A80000T
B Agave 18" Planter	17.75 in 45.1	18.25 in 46.3	13.00 in 33.0	13.50 in 34.3	9.00 gal 34.1	A8800XX	A80000T
Agave 24" Planter	23.75 in 60.3	12.25 in 31.1	18.00 in 45.7	17.25 in 43.8	13.75 gal 51.7	A8800XX	A80000T

Identify the Logos



See the next page for more details.

Quick Ship



In-Stock colors and ready to ship.



Product Brand Identity

CRESCENT
garden

Crescent**TOO**

Identify the Logos



10 Year Warranty

Our 10 Year Warranty against fading, or cracking on our rotationally molded products gives confidence to consumers when purchasing our products.



Circular Positive™, **NEW!**

A circular, continuous approach for plant and planet: these planters are manufactured with an upcycled material made from landfill waste diverting harmful emissions for a more positive environmental impact.



TruDrop System

Our patented TruDrop self-watering delivers phenomenal results with little effort. See more details on page 18



Water Gardening

Easy to install and maintain, these containers are ideal to tap into the water gardening market. With a broad selection of shapes, depths and sizes, these containers can accommodate a variety of water gardening plants and fish. Some of our planters are also supplied with specialty plugs to use with fountain pumps.



No Drainage Holes

Healthy plants start with proper drainage. We design most of our planters with elevated pot feet and drainage holes that are adequately sized for each planter. However, there are times when consumers just need a cache pot or drainage can be an issue. In these case you will find the No Drainage Holes icon on the page.



Double Wall

Double Walled construction provides many benefits including superior structural integrity, enhanced appearance and insulating properties for better thermal protection of plant roots.



Can be Personalized

Some of our planters can be branded with a logo, house number or family name. See page 14.

Quick Ship Program and Special Orders

We provide a wide array of in stock items in our Quick Ship program that are readily available all year round. We consider these to be a selection of our best selling colors in each design and style. These can be viewed throughout the catalog in the individual shots provided on each page.

However, all of our Crescent Garden planters can also be customized in any of the colors below. Check with your customer service representative for lead times, pricing and terms on special orders.

Standard Colors:

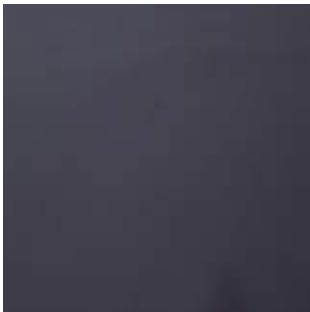

Caviar Black Ref: 94



Old Bronze Ref: 14



Mocha Ref: 44

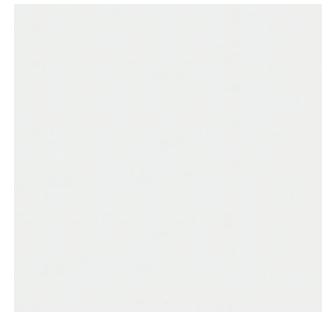

Cloud White Ref: 00



Rust Ref: 33



Weathered Terracotta Ref: 34



Weathered Concrete Ref: 92



Midnight Ref: 55



Olive Ref: 82

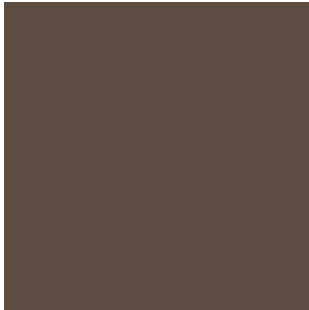

Bark Ref: 74



Currant Ref: 47



Ash Ref: 98



Slate Ref: 97



Parchment Ref: 11



Shadow Ref: 95

Can be Personalized

Make your next project unique by customizing the planters.

- Brand with hotel, city, healthcare facility or park name to delineate campuses and create greater awareness.
- Use for residential properties to identify street or house numbers.
- Create a custom family crest or display a family name to give an entrance a special touch.

Available Styles for Personalization



Pinch Planter



Rim Planter

Let's get started:

Image Requirements:

Vectorized graphic should be provided in any of the following file types: .ai, .eps, .dxf or .pdf. If providing pdf it should be created from a vectorized graphic.

Timeline for Customized Project:

Once images are received, we would provide artwork for approval within 4-5 working days. We would require signature approval on artwork. Once this is returned to us production lead time for Quick Ship items, can be between 4-5 weeks.

Minimums:

Contact us at customerservice@crescentgarden.com, for details on minimums and pricing for customized projects.







 TruDrop ONE



Weeks without Watering

With our TruDrop self-watering, containers can go without watering for 2-6 weeks depending on plant selection and climate.

Easy

With no rocks or wicks, this single-body planter just needs potting soil and plant making it easy even for first time gardeners.



Safe, Efficient

With 50% less water usage and more efficient use of fertilizers that remain in the water cavity, these planters are environmentally friendly.

Dramatically Successful

In our planters with TruDrop the plants determine how much water they need instead of the consumer which renders phenomenal results.

CRESCENT
garden

TruDrop ONE

Finally.
A planter that
works for you.



Easy



Safe



Success



Efficient



Versatile



Water Level Indicator
Easy to read.

Easy To Fill Hole
Includes cap to avoid water contamination.

Double Wall Construction*
Large water reservoir allows plants to go longer without watering.

Mess Free Drain System
Optional quick connect coupling in larger planters facilitates draining planter without spillage.

Can connect directly to hose or pump.



Overfill Drain
When using outdoors, planter is designed to drain excess rain water.

Sealed Bottom
Plug included with planter for indoor use.

Capillary Action
Watering via roots creates healthy plants.

*Outdoor trials using a 20" (50,8 cm) planter have shown that plants **can go for up to 6 weeks without refilling.**

We never expected TruDropOne to change the way people garden but now we hear it from our clients.

“

“I returned home from **two weeks’ vacation...** and was very happy to see that my TruDrop planter did its job while I was away.”

Jed Laufferty, West Chester, Pennsylvania, U.S.A



“

“I think these are the **best** things since sliced bread lol.”

Jed Susan, Ontario, Canada

“

“They work great for me, as we live at a **lake home** with 6 outdoor pots and we are gone from our home several times a month for anywhere from a couple days to a week. With your pots, my flowers now make it through the summer without dying from lack of water.”

Debbie, Minnesota, U.S.A

“

“TruDrop’s claims that watering is only needed every two to six weeks sounded a little far-fetched, but... (It) works better than I ever imagined.”

Heather Rhoades, **Gardening Know How**

“

I got 26 days out of it... I **saved** that much **time** watering!

Laura LeBoutillier, **Garden Answer**, Oregon, U.S.A



“

“The pottery is **gorgeous** by the way! We have one very happy customer - can't wait to order more!”

Erin, **Landscape Solutions Company**, Tennessee, U.S.A



“

"We are a Boutique Resort in beautiful St. Croix, US Virgin Islands. For years we have searched for planters which could withstand our sun and sea elements and still have a classy and elegant presence. The planters are very easy to set up, plant and maintain. The guests continually compliment the elegance and beauty. We can not say enough about the quality of product and customer service."

Sand Castle on the Beach Hotel, Virgin Islands, U.S.A.

“

"Where we were once watering every day, we are now able to simply "top off" each planter once a week. The savings in man power have been exponential."

Mark Russel (Director of Horticulture),
SeaWorld Parks and Entertainment
Orlando, U.S.A.

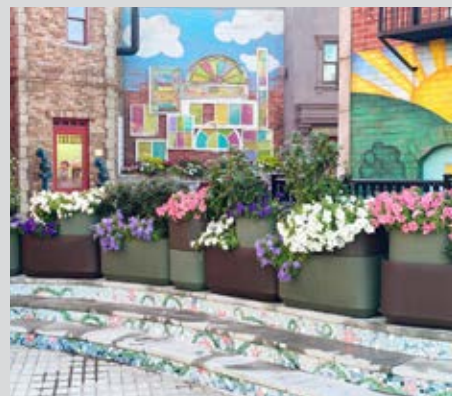

“

"They have sixteen Pinch in Lawrence. I wouldn't use anything else now for city planters it saves me a lot of watering time! I have 34 estate planters in the city next to Lawrence, Haverhill. I have to water those every third day. Not with the Pinch."

Steve Nunan - Massachussetts
Nunan's Florist and Greenhouse, U.S.A.



Crescent Garden: Design Ideas



Edibles in Small Spaces:
Our Nest planters are ideal to grow edibles even in spaces with no garden.



Step it up:
With the 14" width Mod planters it is easy to bring green to narrow spaces.



Midnight Blue:

A great replacement for black, Midnight will add elegance to any space.

Crescent Garden: Design Ideas



Commercial Applications:

With TruDrop a commercial space can be retrofitted with new planters without the investment of costly sub-irrigation installations.



RESTAURANT & BAR



Narrow and Tall:
Instead of traditional urns these curved Cup planters make elegant entryways.



Supersize:

When you have a door that is over 7 feet tall make sure you use a planter proportionate like the Rim 30".



Better Economics:

TruDrop self-watering allows properties to maintain planters at a fraction of the regular cost giving them flexibility to add green in more places.

Cup Tall Planters

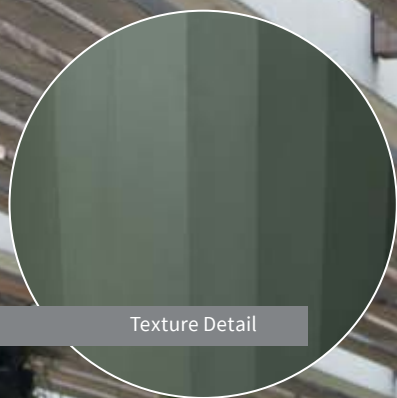

Texture Detail



Bark and Olive

		dimensions				volume capacity		planter ref.#	saucer ref.#
		soil	water	soil	water				
A	Cup Tall 16" Planter	15.75 in 40,0 cm	9.61 in 24,4 cm	11.58 / 11.02 in 29,4 / 28,4 cm	29.53 in 75,0 cm	6.16 gal 23,3 l	3.17 gal 12,0 l	A6440XX	A9910XXT
B	Cup Tall 19" Planter	18.70 47,5	11.22 28,5	14.53 / 14.96 36,9 / 38,0	34.65 88,0	11.29 42,7	5.65 21,4	A6447XX	A9913XXT

Make sure to order mess-free drain couplings if you will be emptying water cavity on a delicate surface. See page 53.



IN-STOCK QUICK SHIP COLORS



Caviar Black Ref: 94



Cloud White Ref: 00



Slate Ref: 97



Midnight Ref: 55



Olive Ref: 82

* 10 Year Limited Warranty covers planter shell only.

Dot Planters



Texture Detail



Cloud White

		dimensions				volume capacity		planter ref.#	saucer ref.#
						soil	water		
A	Dot 16" Planter**	16.00 in 40,6 cm	9.80 in 24,9 cm	12.80 / 6.90 in 32,5 / 17,5 cm	16.00 in 40,6 cm	3.59 gal 13,6 l	2.14 gal 8,1 l	A5940XX	A9910XXT
B	Dot 20" Planter	20.00 50,8	12.28 31,2	16.21 / 9.45 41,2 / 24,0	20.04 50,9	7.36 27,9	5.42 20,5	A5950XX	A9913XXT
C	Dot 26" Planter	26.00 66,0	15.96 40,5	22.21 / 12.00 56,4 / 30,5	26.04 66,1	19.59 74,2	12.8 48,5	A5965XX	A9918XXT

Make sure to order mess-free drain couplings if you will be emptying water cavity on a delicate surface. See page 63.



IN-STOCK QUICK SHIP COLORS



Cloud White Ref: 00



Midnight Ref: 55



Ash Ref: 98

* 10 Year Limited Warranty covers planter shell only.

** This size does not include a side drain and cannot accommodate a mess free drainage system.

Mod Family of Planters





Mod Family of Planters

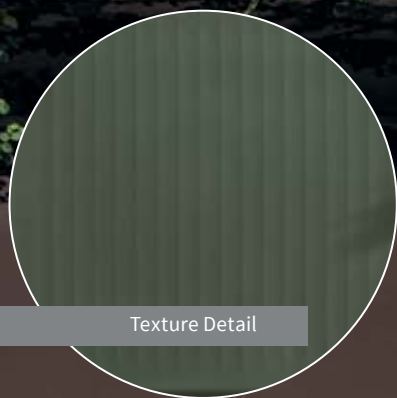







Texture Detail

RESTAURANT & BAR

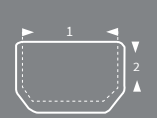

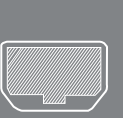
Cloud White, Ash and Olive

Planters in 20" (51 cm) width Planters in 14" (36 cm) width		dimensions			volume capacity		planter ref.#
					soil	water	
							
A	Mod Low Square 20" x 20" x 16"H	19.7 x 19.7 in 50,0 x 50,0 cm	14.96 x 15.35 / 14.76 in 38,0 x 39,0 / 37,5 cm	15.75 in 40,0 cm	8.85 gal 33,5 l	7.93 gal 30,0 l	A6140XX
B	Mod Large Trough 40" x 20" x 20"H	39.3 x 19.7 99,8 x 50,0	35.04 x 15.75 / 18.70 in 89,0 x 40,0 / 47,5 cm	19.69 in 50,0 cm	26.95 gal 102,0 l	19.55 gal 74,0 l	A6150XX
C	Mod Tall Square 20" x 20" x 38"H	19.7 x 19.7 50,0 x 50,0	14.96 x 14.96 / 37.40 in 38,0 x 38,0 / 95,0 cm	38.19 in 97,0 cm	19.55 gal 74,0 l	15.85 gal 60,0 l	A6197XX
D	Mod 20" Tall and Narrow 20" x 14" x 24"H	19.7 x 13.8 50,0 x 35,1	14.96 x 9.06 / 16.34 in 38,0 x 23,0 / 41,5 cm	23.62 in 60,0 cm	5.34 gal 20,2 l	12.63 gal 47,8 l	A6160XX
E	Mod 40" Tall and Narrow 40" x 14" x 30"H	39.3 x 13.8 99,8 x 35,1	33.07 x 9.06 / 28.35 in 84,0 x 23,0 / 72,0 cm	29.53 in 75,0 cm	22.72 gal 86,0 l	19.94 gal 75,5 l	A6175XX
F	Mod Mini Trough 20" x 14" x 12"H **	19.7 x 13.8 50,0 x 35,1	14.96 x 9.06 / 11.02 in 38,0 x 23,0 / 28,0 cm	11.81 in 30,0 cm	4.20 gal 15,9 l	3.34 gal 12,6 l	A6130XX

Make sure to order mess-free drain couplings if you will be emptying water cavity on a delicate surface. See page 63.



IN-STOCK QUICK SHIP COLORS



Caviar Black Ref: 94



Cloud White Ref: 00



Ash Ref: 98



Slate Ref: 97



Midnight Ref: 55



Olive Ref: 82

* 10 Year Limited Warranty covers planter shell only.

** This size does not include a side drain and cannot accommodate a mess free drainage system.

Six different sizes.
Move them, stack them,
and create your own space.



Mod planters in 20 in (51 cm) width



Mod planters in 14 in (36 cm) width

Mod planters maximum stack is 2 planters only.



Mod planters with 20 in (51 cm) width



Mod Low Square
20" x 20" x 16"H
A6140XX

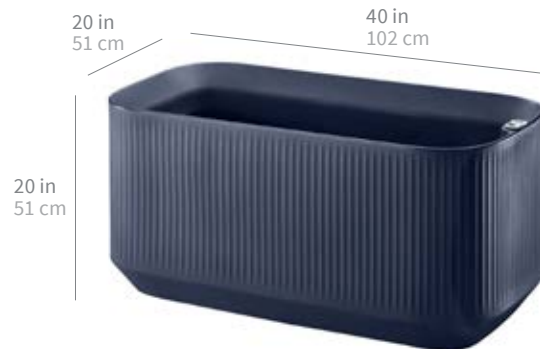

Mod Large Trough
40" x 20" x 20"H
A6150XX



Mod Tall Square
20" x 20" x 38"H
A6197XX

Mod planters with 14 in (36 cm) width

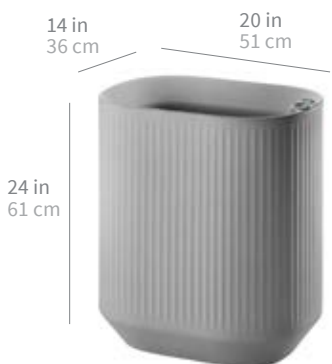

Mod 20" Tall and Narrow
20" x 14" x 24"H
A6160XX

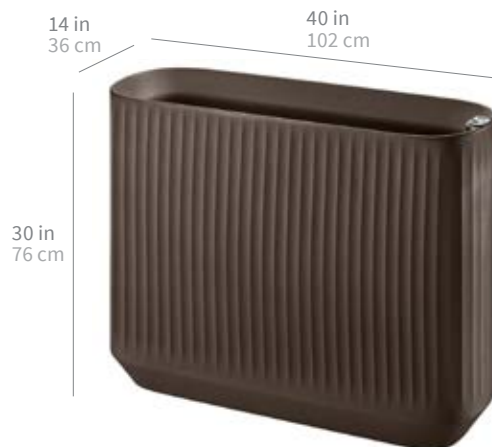

Mod 40" Tall and Narrow
40" x 14" x 30"H
A6175XX

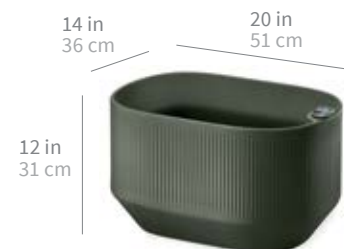

Mod Mini Trough
20" x 14" x 12"H
A6130XX

Nest Planters



Cloud White



Cloud White



Cloud White



Bark



Slate and Olive in back







Nest Planters



Texture Detail

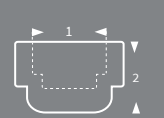

Slate and Olive in back

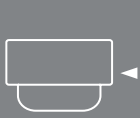
		dimensions			soil volume capacity	water volume capacity	planter ref.#
							
A	Nest 18" x 36" Raised Planter	18.00 x 36.00 in 45,7 x 91,4 cm	13.03 x 31.34 / 9.05 in 33,1 x 79,6 / 23,0 cm	16.00 in 40,6 cm	13.21 gal 50,0 l	6.67 gal 25,2 l	A6249XX
B	Nest 22" x 44" Raised Planter	22.00 x 44.00 55,9 x 111,8	17.22 x 39.27 / 9.05 43,7 x 99,7 / 23,0	16.00 in 40,6	22.80 86,3	12.25 46,4	A6251XX
C	Nest 30" x 48" Raised Planter	30.00 x 48.00 76,2 x 121,9	25.24 x 42.96 / 9.06 64,1 x 109,1 / 23,0	16.00 in 40,6	40.15 152,0	18.49 70,0	A6271XX

Make sure to order mess-free drain couplings if you will be emptying water cavity on a delicate surface. See page 63.

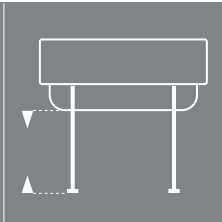
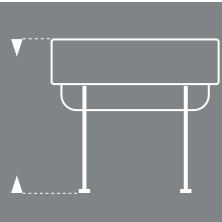
Nest Height with Legs			
			
A, B, C	20.00 in 50,8 cm	36.00 in 91,4 cm	



IN-STOCK QUICK SHIP COLORS



Cloud White Ref: 00



Slate Ref: 97



Olive Ref: 82

* 10 Year Limited Warranty covers planter shell only.



		dimensions				product ref.#
		Width		Height		
A	Trellis for 18" Nest Raised Planter	17.60 44,7	in cm	28.00 71,1	in cm	AZ631894
	Trellis for 22" Nest Raised Planter	22.00 55,9		28.00 71,1		AZ632294
	Trellis for 30" Nest Raised Planter	29.80 75,7		28.00 71,1		AZ633094
B	Greenhouse Cover for 18" Nest Raised Planter (includes storage bag)	18.20 x 36.50 46,2 x 92,7		26.40 67,1		AZ641800
	Greenhouse Cover for 22" Nest Raised Planter (includes storage bag)	22.70 x 44.70 57,7 x 113,5		26.40 67,1		AZ642200
	Greenhouse Cover for 30" Nest Raised Planter (includes storage bag)	30.50 x 48.20 77,5 x 122,4		26.40 67,1		AZ643000
C	Hooks for Nest Raised Planter (Bag of 2)	3.00 7,6		3.50 8,9		AZ670094C

A - Trellis for Nest Raised Planter



B - Greenhouse Cover for Nest Raised Planter



C - Hook for Nest Raised Planter



Pinch Planters







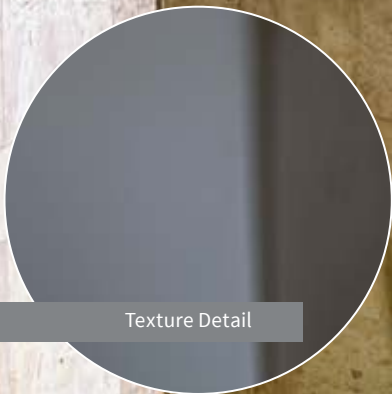



Pinch Planters

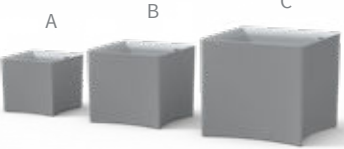

Texture Detail



Slate

		dimensions			soil volume capacity	water volume capacity	planter ref.#
							
A	Pinch 23" Planter	22.52 in 57,2 cm	21.85 x 19.69 / 10.04 in 55,5 x 50,5 / 25,2 cm	20.28 in 51,5 cm	11.73 gal 44,4 l	9.91 gal 37,5 l	A6757XX
B	Pinch 29" Planter	28.98 73,6	28.35 x 26.38 / 12.60 72,0 x 67,0 / 32,0	26.06 66,2	26.95 102,0	24.57 93,0	A6774XX
C	Pinch 37" Planter	36.93 93,8	36.30 x 34.65 / 15.75 92,2 x 88,0 / 40,0	33.27 84,5	60.76 230,0	55.48 210,0	A6794XX

Make sure to order mess-free drain couplings if you will be emptying water cavity on a delicate surface. See page 63.



IN-STOCK QUICK SHIP COLORS



Slate Ref: 97



Olive Ref: 82



Currant Ref: 47

* 10 Year Limited Warranty covers planter shell only.

Rim Planters













Rim Planters



Texture Detail



		dimensions				soil volume capacity	water volume capacity	planter ref.#	saucer ref.#
									
A	Rim 18" Planter**	17.70 in 45,0 cm	9.84 in 25,0 cm	13.00 / 8.86 in 33,0 / 22,5 cm	17.91 in 45,5 cm	5.14 gal 19,5 l	3.92 gal 14,8 l	A6045XX	A9910XXT
B	Rim 22" Planter	21.60 54,9	12.60 32,0	17.00 / 10.83 43,2 / 27,5	21.85 55,5	9.95 37,7	7.32 27,7	A6055XX	A9913XXT
C	Rim 26" Planter	25.60 65,0	14.96 38,0	21.00 / 12.80 53,3 / 32,5	25.79 65,5	17.73 67,1	11.86 44,9	A6065XX	A9915XXT
D	Rim 30" Planter	29.60 75,2	17.71 45,0	25.00 / 14.76 63,5 / 37,5	29.72 75,5	27.94 105,8	19.91 75,4	A6075XX	A9990XXT

Make sure to order mess-free drain couplings if you will be emptying water cavity on a delicate surface. See page 63.



IN-STOCK QUICK SHIP COLORS



Caviar Black Ref: 94



Cloud White Ref: 00



Ash Ref: 98



Slate Ref: 97



Midnight Ref: 55



Olive Ref: 82



Currant Ref: 47

* 10 Year Limited Warranty covers planter shell only.

** This size does not include a side drain and cannot accommodate a mess free drainage system.

Slat of Planters

NEW



Slate



Slate



Slat of Planters

NEW



Caviar Black



Slat Planter Boxes

NEW

Texture Detail



Caviar Black

		dimensions			volume capacity		planter ref.#
					soil	water	
A	Slat Square 22" Planter	22.48 x 22.48 in 57,1 x 57,1 cm	17.72 / 12.20 in 45,0 / 31,0 cm	19.69 in 50,0 cm	14.66 gal 55,5 l	10.30 gal 39,0 l	A8157XX
B	Slat Medium Deck Box 36" x 17" x 17"H Planter	35.87 x 17.95 91,1 x 45,6	31.18 / 9.09 79,2 / 23,1	16.54 42,0	15,59 59,0	11.36 43,0	A8191XX
C	Slat Large Deck Box 47" x 19" x 23"H Planter	46.65 x 19.09 118,5 x 48,5	41.89 / 15.35 106,4 / 39,0	22.83 58,0	35.53 134,5	17.38 65,8	A81118XX

Make sure to order mess-free drain couplings if you will be emptying water cavity on a delicate surface. See page 63.

Caster Plates Size Small and Anti-Theft Bracket systems available - Page 60 - 62



Caster Plates:
Order 1 unit for Small and 2 units for Medium and Large Planters.



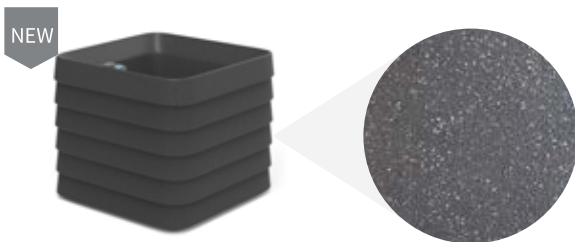

IN-STOCK QUICK SHIP COLORS



Shadow Ref: 95

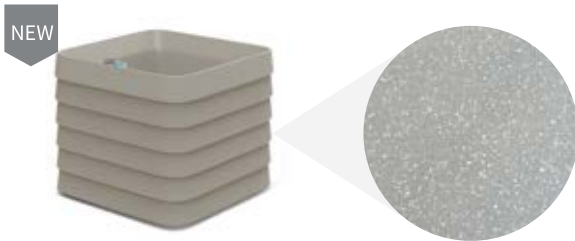

Slate Ref: 97



Parchment Ref: 11

* 10 Year Limited Warranty covers planter shell only.

Slat Window Boxes

NEW

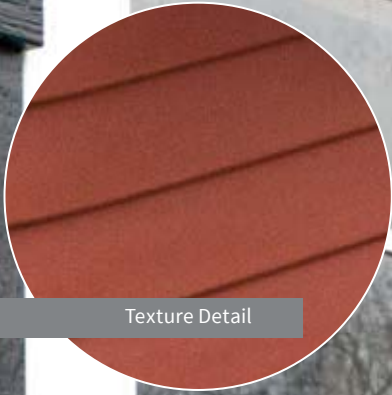

Texture Detail



Currant

	A B C	dimensions			volume capacity		planter ref.#
		soil	water				
A	Slat Small Window Box 23" x 13" x 12"H Planter	23.07 x 12.60 in 58,6 x 32,0 cm	18.70 / 6.69 in 47,5 / 17,0 cm	11.81 in 30,0 cm	4.76 gal 18,0 l	3.88 gal 14,7 l	A8258XX
B	Slat Medium Window Box 35" x 13" x 12"H Planter	34.88 x 12.60 88,6 x 32,0	30.51 / 6.69 77,5 / 17,0	11.81 30,0	7.93 30,0	5.81 22,7	A8288XX
C	Slat Large Window Box 47" x 13" x 12"H Planter	46.69 x 12.60 118,6 x 32,0	42.32 / 6.69 107,5 / 17,0	11.81 30,0	11.20 42,4	7.93 30,0	A82118XX
D	Metal Bracket for wall mounting Slat Window Boxes (Order 2 units for Small and Medium window box, order 3 for Large.)	10.14 x 0.79 25,8 x 2,0	N/A	11.81 30,3	N/A	N/A	AR07

Make sure to order mess-free drain couplings if you will be emptying water cavity on a delicate surface. See page 63.



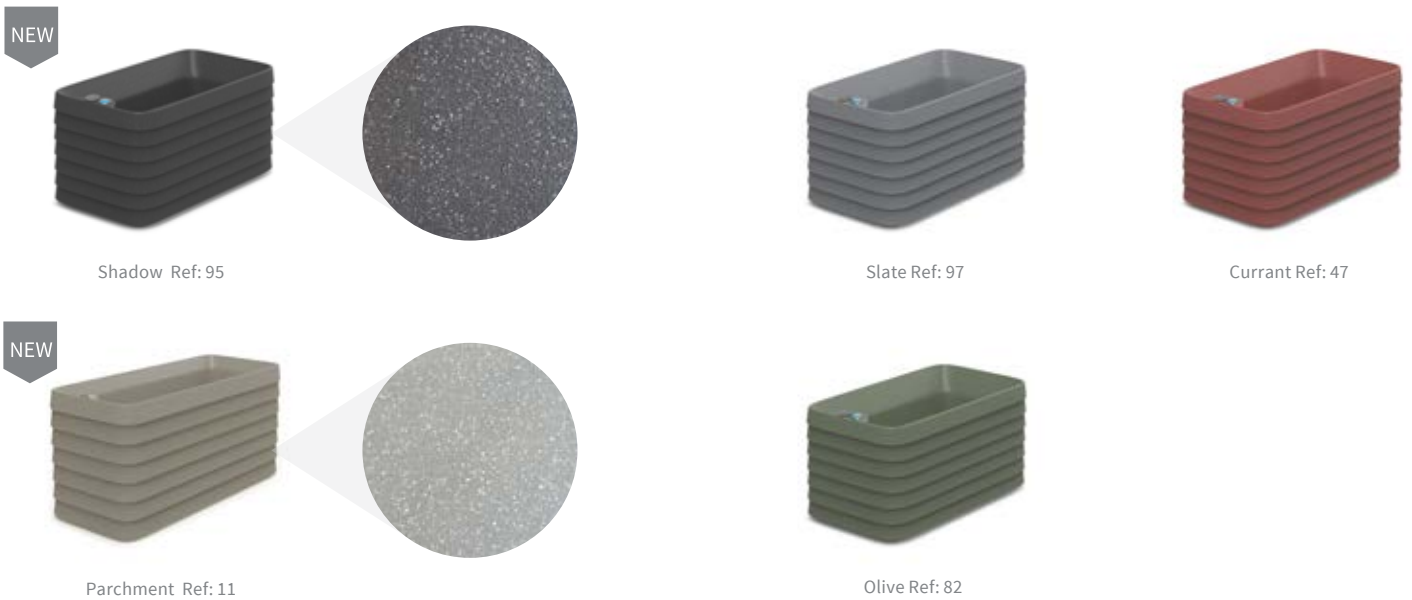

IN-STOCK QUICK SHIP COLORS



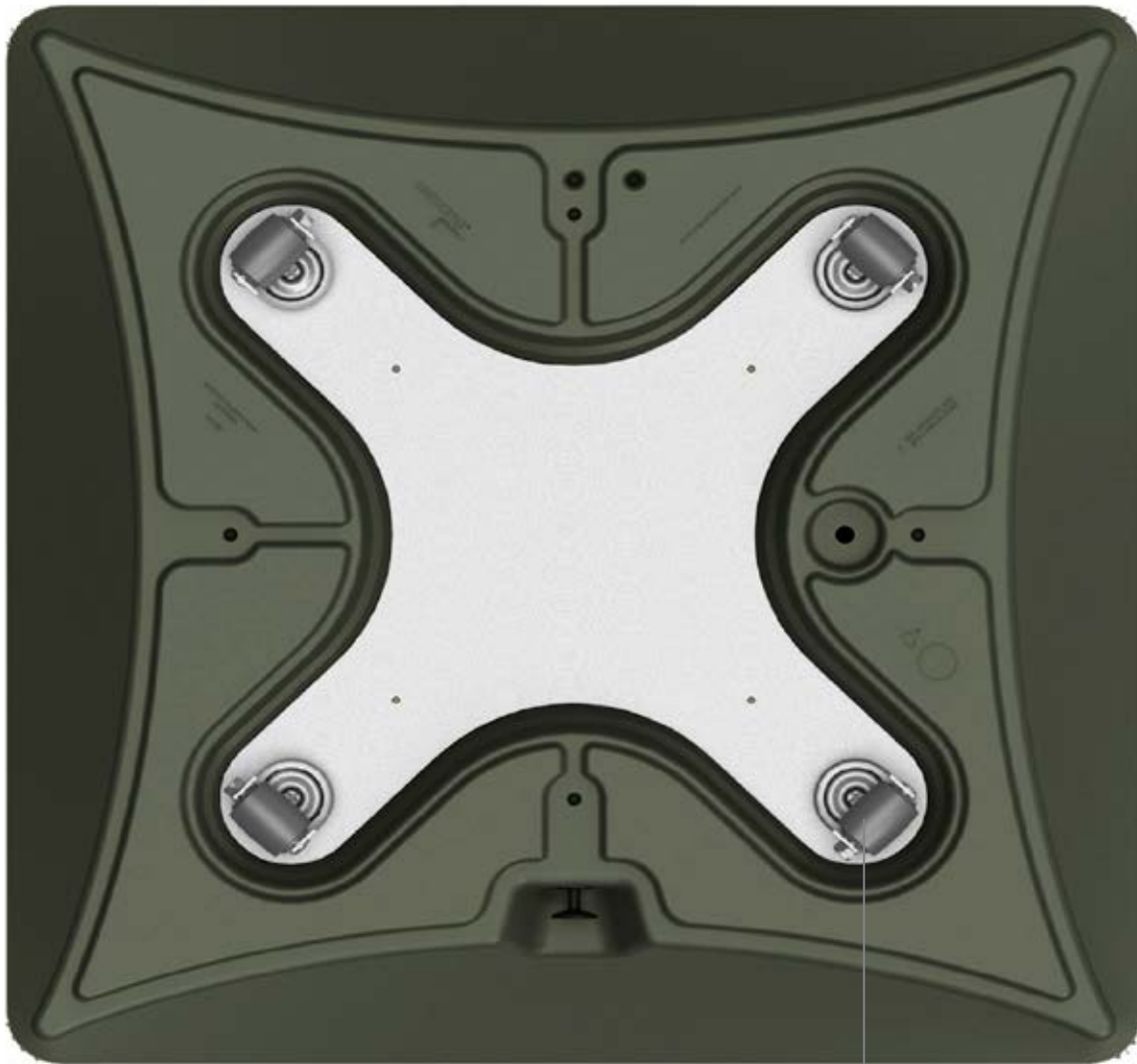













* 10 Year Limited Warranty covers planter shell only.



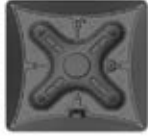

Rotating, recessed caster base
can be added for mobility.

 A	dimensions				product ref.#				
									
A	Caster System S - for 23" Pinch Planter or Slat Planter Boxes				13.50 45,8	in cm	13.50 45,8	in cm	AR03B
	Caster System M - for 29" Pinch Planter				24.02 61,0		24.02 61,0		AR04B
	Caster System L - for 37" Pinch Planter				33.50 85,1		33.50 85,1		AR05B

Each caster plate can support up to 1,320 pounds (600 kg).

Caster System	Slat Planter Boxes			Pinch Planters		
	Square 22"	Medium Deck Box	Large Deck Box	23" Pinch	29" Pinch	37" Pinch
	 	 	 	 	 	 
Small 	x1	x2	x2	x1	-	-
Medium 	-	-	-	-	x1	-
Large 	-	-	-	-	-	x1

TruDrop One - Add-ons for Pinch Planters and Slat Planter Boxes

	dimensions				product ref.#
					
A Anti-Theft Brackets System for Pinch Planter or Slat Planter Boxes (Set of 4)	4.64 11,8	in cm	1.10 2,8	in cm	AR06K1

Anti-theft brackets can be added to attach planter to concrete where needed.



TruDrop One - Easy Drain System



	description	product ref.#
A	Easy Drain Screw Cap	AZ600588
B	Easy Drain barbed pull drain plug	BT002P193
C	Coupler for Easy Drain Screw Cap (0.5'' (1,27 cm) Barb)	AZ605088B
D	Coupler for Easy Drain Screw Cap (0.75'' (1,9 cm) Barb)	AZ607588B

Make sure to order mess-free drain couplings if you will be emptying water cavity on a delicate surface.

How easy drain works



A or B

Replace the standard cap on the mouse hole opening at the bottom of the planter with the Easy Drain Screw cap or barbed pull drain cap depending on the planter selected.



C

When you are ready to drain the planter just use the coupler to connect to a standard garden hose. Hose can then be directed to a bucket or a green area away from decks or delicate floors.



Replacement Parts for TruDrop One Planters





description	A - indicator ref. #	B - NEW indicator ref. #
TruDrop One Water Level Indicator		
TruDrop One Water Level Indicator for Cup 16" Planter	T01288188S	BT01742547
TruDrop One Water Level Indicator for Cup 19" Planter	T01339244S	BT01872635
TruDrop One Water Level Indicator for Cup 22" Planter	T01386287S	BT01994677
TruDrop One Water Level Indicator for Dot 16" Planter	T01152086S	BT01384251
TruDrop One Water Level Indicator for Dot 20" Planter	N/A	BT01485326
TruDrop One Water Level Indicator for Dot 26" Planter	N/A	BT01642424
TruDrop One Water Level Indicator for Mod 20" x 20" x 38"H Planter	T01375287S	BT01960770
TruDrop One Water Level Indicator for Mod 20" x 14" x 12" Planter	T01110059S	BT01290234
TruDrop One Water Level Indicator for Mod 20" x 14" x 24" Planter	T01228103S	BT01587310
TruDrop One Water Level Indicator for Mod 20" x 20" x 16" Planter	T01149093S	BT01380310
TruDrop One Water Level Indicator for Mod 40" x 14" x 30"H Planter	T01287191S	BT01732594
TruDrop One Water Level Indicator for Mod 40" x 20" x 20" Planter	T01189131S	BT01485395
TruDrop One Water Level Indicator for Nest Raised Planters (Small, Medium and Large)	N/A	BT01389326
TruDrop One Water Level Indicator for Rim 18" Planter	N/A	BT01447326
TruDrop One Water Level Indicator for Rim 22" Planter	N/A	BT01537364
TruDrop One Water Level Indicator for Rim 26" Planter	N/A	BT01640435
TruDrop One Water Level Indicator for Rim 30" Planter	N/A	BT01742472
TruDrop One Water Level Indicator for Slat Square 22" Planter	N/A	BT01481391
TruDrop One Water Level Indicator for Slat Medium Deck Box 36" x 17" x 17"H Planter	N/A	BT01403322
TruDrop One Water Level Indicator for Slat Large Deck Box 47" x 19" x 23"H Planter	N/A	BT01558463
TruDrop One Water Level Indicator for Slat Window Box (Small, Medium and Large)	N/A	BT01282223
TruDrop One Water Level Indicator for Pinch 23" Planter	N/A	BT01502326
TruDrop One Water Level Indicator for Pinch 29" Planter	N/A	BT01647484
TruDrop One Water Level Indicator for Pinch 37" Planter	N/A	BT01834655

description	product ref.#
Leg Sets for Small Nest	
C Leg Sets for Small Nest (Replacement)	AZ651894
C Leg Sets for Medium Nest (Replacement)	AZ652294
C Leg Sets for Large Nest (Replacement)	AZ653094
Water Caps and Plugs	
D Replacement Water Cap intake	Y0000102
E Replacement White Drain Cap	805024
F Replacement Red Plug for Overflow Drain	8080
G TruDrop Pouch with Replacement Drain plug, rubber insert & red plug	C024-000



made with **ubq**™



Introducing
Crescent**TOO**⁺

The **first** planter **of its kind**
made with **climate-positive** UBQ™ Material
for a **planet-positive** impact

The
Circular

Positive +
Planter

PRODUCTION AND LIFECYCLE

Upcycled from waste
Reduces landfill and emissions
Re-recyclable planters

IMPACT ON SUSTAINABILITY

Material **reduces** harmful emissions
Plant-positive containers & inserts
For a **Planet-Positive** environment

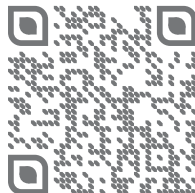

Learn More



Crescent**TOO**

 **TruDrop**FLEX



New Circular Positive ™

Our TruDrop Flex planters are now made with climate-positive UBQ materials, upcycled from landfill waste, diverting harmful emissions for a positive environmental impact.

Mix and Match

Complete flexibility from grower, to garden center, to consumer. Plants can be grown in insert and covers selected to reflect desired style.

Optional TruDrop Self Watering

Purchase with insert to go weeks without watering for phenomenal results and successful gardening.

Value Solution

Single wall planters can be used on their own or with TruDrop self watering insert. Accessible to everyone.

Mix and Match

CrescentTOO | TruDrop FLEX



Find a program that works for you.



Grab and Go Containers:

Grow in nursery, display in garden center. Allow consumer to customize with their style in mind.



Build your Own:

Allow consumers to make their own TruDrop Flex self-watering container by purchasing cover and inserts in the store.



10 Year Warranty Planters:

Offer covers as stand alone containers at a great value.

Fold Planters

NOW
Sold Individually

Sleek and Simple:
Our understated Fold planter will work
in any environment.



Optional Insert:
Up to weeks without watering for
great results: TruDrop Flex.

Fold Planters



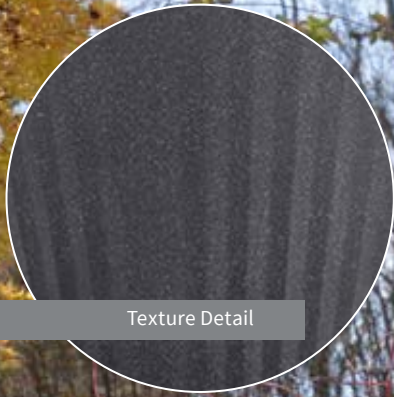



NOW
Sold Individually



Texture Detail



Bedrock Circular+

		dimensions						volume capacity		planter ref.#
										
A	Fold 15" Planter (Small)	14.96 38,0	in cm	9.37 23,8	in cm	13.58 34,5	in cm	6.08 23,0	gal l	B09015MXXX
B	Fold 18" Planter (Medium)	18.11 46,0		9.45 24,0		16.69 42,4		10.88 41,2		B09018MXXX
C	Fold 22" Planter (Large)	22.05 56,0		13.39 34,0		19.88 50,5		19.55 74,0		B09022MXXX

Add TruDrop Flex insert for self-watering alternative. Page 83



IN-STOCK QUICK SHIP COLORS



Autumn Circular+ Ref: U33



Bedrock Circular+ Ref: U93



Juniper Circular+ Ref: U60



Coal Circular+ Ref: U94

Ridge Planters





NOW
Sold Individually



Texture Detail



Autumn Circular+

		dimensions						volume capacity	planter ref.#	
										
A	Ridge 15" Planter (Small)	14.96 38,0	in cm	8.86 22,5	in cm	13.58 34,5	in cm	5.55 21,0	gal l	B08815MXXX
B	Ridge 18" Planter (Medium)	18.11 46,0		9.45 24,0		16.69 42,4		10.30 39,0		B08818MXXX
C	Ridge 22" Planter (Large)	22.05 56,0		12.52 31,8		19.88 50,5		18.49 70,0		B08822MXXX

Add TruDrop Flex insert for self-watering alternative. Page 83



IN-STOCK QUICK SHIP COLORS



Autumn Circular+ Ref: U33



Bedrock Circular+ Ref: U93



Juniper Circular+ Ref: U60



Coal Circular+ Ref: U94

Step Planters

NOW
Sold Individually



Step into a New Age:
Inspired by mid-century design, our Step
planters are a hit with young gardeners.







Step Planters

NOW
Sold Individually

Texture Detail

Bedrock Circular+



		dimensions						volume capacity	planter ref.#	
										
A	Step 15" Planter (Small)	14.96 38,0	in cm	8.86 22,5	in cm	13.58 34,5	in cm	6.08 23,0	gal l	B08915MXXX
B	Step 18" Planter (Medium)	18.11 46,0		9.45 24,0		16.69 42,4		11.10 42,0		B08918MXXX
C	Step 22" Planter (Large)	22.05 56,0		12.87 32,7		19.88 50,5		19.81 75,0		B08922MXXX

Add TruDrop Flex insert for self-watering alternative. Page 83



IN-STOCK QUICK SHIP COLORS



Autumn Circular+ Ref: U33



Bedrock Circular+ Ref: U93



Juniper Circular+ Ref: U60



Coal Circular+ Ref: U94

TruDrop Flex - Insert and Water Gauge





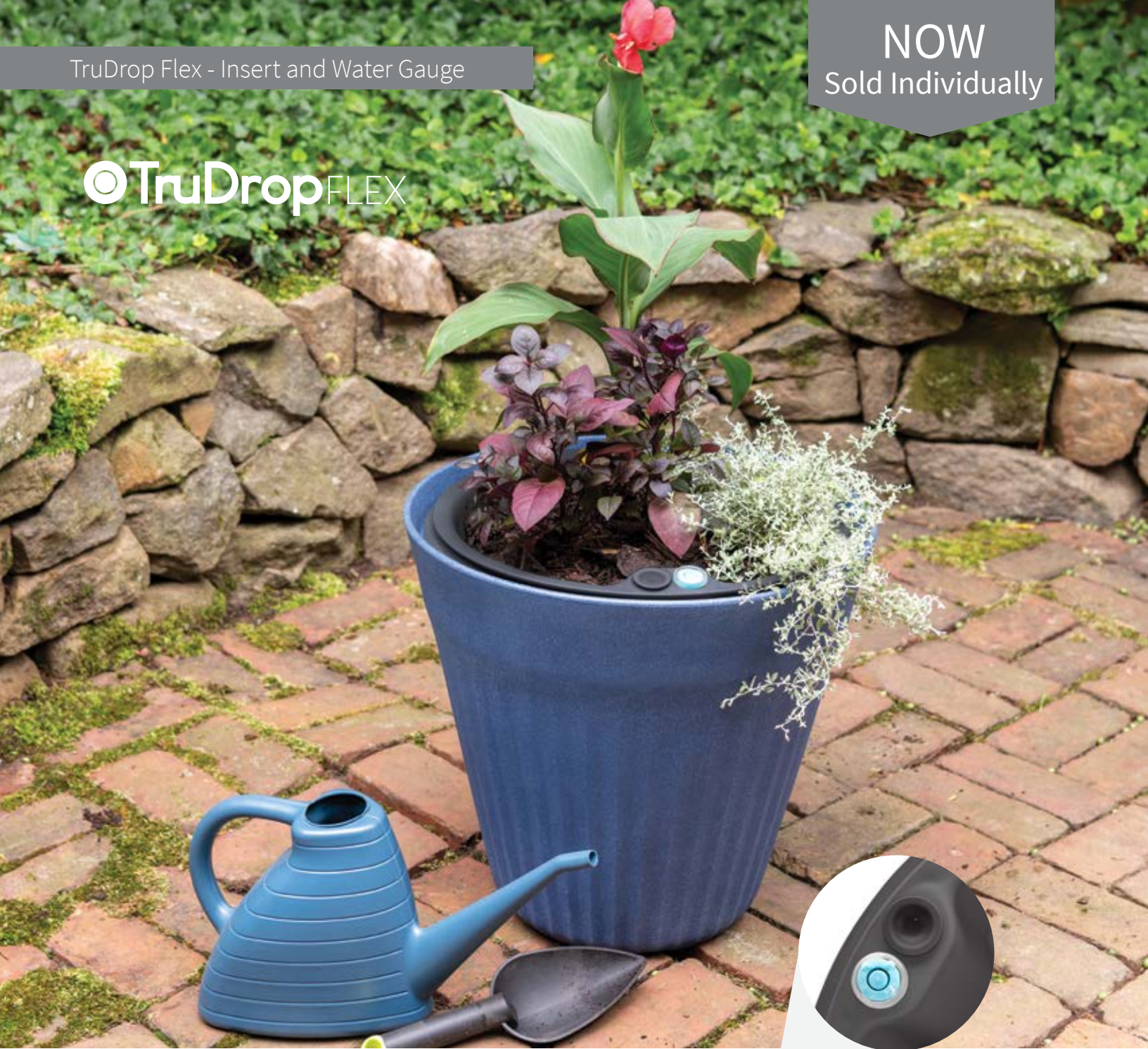

NOW
Sold Individually

© TruDrop FLEX



+



		dimensions			volume capacity		insert ref.#			
		soil		water						
										
A	Insert, Water Gauge and Cap 15" Planters (Small)	13.54 34,4	in cm	8.66 22,0	in cm	12.91 32,8	in cm	2.59 gal 9,8 l	1.74 gal 6,6 l	BT001I15193
B	Insert, Water Gauge and Cap 18" Planters (Medium)	16.69 42,4		10.24 26,0		15.59 39,6		4.49 17,0	3.70 14,0	BT001I18193
C	Insert, Water Gauge and Cap 22" Planters (Large)	20.63 52,4		12.20 31,0		18.94 48,1		9.25 35,0	6.21 23,5	BT001I22193



20 pcs of insert 18" are stacked, shipped inside another box

Easy to read water level indicator.

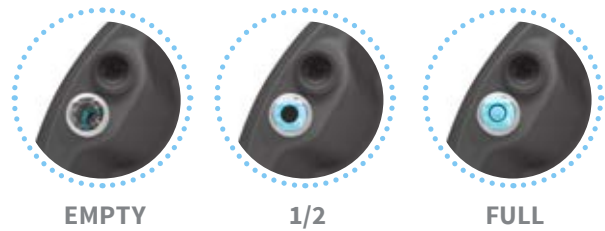



Crescent**TOO**⊕



First of its Kind

The world's first plant container made with an innovative climate positive material. A breakthrough planet-positive container for a plant-positive impact.

Upcycled from Waste

Made with UBQ™ material, upcycled from landfill waste. The Circular positive planter is a step beyond ordinary recyclable and carbon-neutral materials. Less waste, less emissions, and a circular lifecycle to continuously use and re-use.

Everyday Planter

The best-selling planter collection that translates everyday gardening into an elevated garden experience. Attractive accessible planters for a dream garden.

Made in Italy





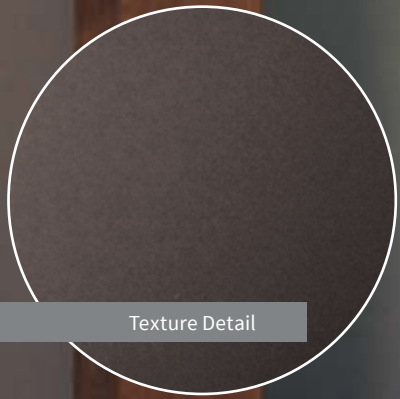

This durable style is lightweight and classic, providing great value for both indoor and outdoor garden design. The planter for every gardener – no matter what step in their journey.





Emma Circular Positive Planters



Texture Detail

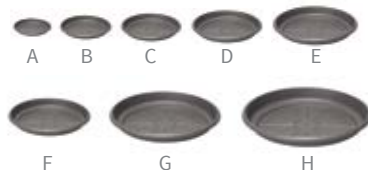

		dimensions						volume capacity		planter ref.#
										
A	Emma 8" Planter (Bag of 12)	7.87 in	20,0 cm	4.75 in	12,1 cm	5.91 in	15,0 cm	0.66 gal	2,5 l	AZ1408UXXC
B	Emma 9" Planter (Bag of 12)	9.00	22,9	5.00	12,7	7.50	19,1	1.10	4,2	AZ1409UXXC
C	Emma 10" Planter (Bag of 12)	10.24	26,0	6.10	15,5	8.30	21,1	1.60	6,1	AZ1410UXXC
D	Emma 12" Planter (Bag of 12)	12.00	30,5	6.75	17,1	10.00	25,4	2.40	9,1	AZ1412UXXC
E	Emma 14" Planter (Bag of 12)	13.78	35,0	8.00	20,3	11.42	29,0	3.70	14,0	AZ1414UXXC
F	Emma 16" Planter (Bag of 6)	15.70	39,9	9.00	22,9	13.00	33,0	5.30	20,1	AZ1416UXXC
G	Emma 18" Planter (Bag of 6)	18.00	45,7	10.5	26,7	13.50	34,3	7.90	29,9	AZ1418UXXC
H	Emma 22" Planter (Bag of 6)	21.50	54,6	13.25	33,7	16.50	41,9	13.20	50,0	AZ1422UXXC

		dimensions				saucer ref.#
						
A	Emma 7" Saucer for 8" Planter (Bag of 12)	7.09 in	18,0 cm	1.06 in	2,7 cm	AZ9907UXXTC
B	Emma 8" Saucer for 9" Planter (Bag of 12)	7.90	18,0	1.10	2,8	AZ9908UXXTC
C	Emma 8.5" Saucer for 10" Planter (Bag of 12)	8.66	22,0	1.18	3,0	AZ9985UXXTC
D	Emma 9.5" Saucer for 12" Planter (Bag of 12)	9.40	23,9	1.30	3,3	AZ9909UXXTC
E	Emma 12" Saucer for 14" Planter (Bag of 12)	11.80	30,0	1.60	4,1	AZ9912UXXTC
F	Emma 13" Saucer for 16" Planter (Bag of 6)	13.00	33,0	1.80	4,6	AZ9913UXXTC
G	Emma 15" Saucer for 18" Planter (Bag of 6)	15.00	38,1	2.00	5,1	AZ9915UXXTC
H	Emma 18" Saucer for 22" Planter (Bag of 6)	18.10	46,0	2.20	5,6	AZ9918UXXTC



IN-STOCK QUICK SHIP COLORS



Terracotta Circular+ Ref: U30



Charcoal Circular+ Ref: U93



LARGE DISPLAY
Emma Circular Positive Planters and Saucers



SMALL DISPLAY
Emma Circular Positive Planters

A - LARGE DISPLAY

Emma Round Circular Positive Planters and Saucers

(Terracotta and Charcoal)



Minimum Order for Free Display:
AZ19DISP1

product ref. #	product description	total bags	Option 1		Option 2	
			charcoal	terracotta	charcoal	terracotta
	Large Display	1	-	-	-	-
AZ1409UXXC	Emma 9" Planter (Bag of 12)	3	2	1	1	2
AZ1412UXXC	Emma 12" Planter (Bag of 12)	3	2	1	1	2
AZ1414UXXC	Emma 14" Planter (Bag of 12)	3	2	1	1	2
AZ1416UXXC	Emma 16" Planter (Bag of 6)	6	4	2	2	4
AZ1418UXXC	Emma 18" Planter (Bag of 6)	6	4	2	2	4
AZ9908UXXTC	Saucer for Emma 9" Planter (Bag of 12)	3	2	1	1	2
AZ9909UXXTC	Saucer for Emma 12" Planter (Bag of 12)	3	2	1	1	2
AZ9912UXXTC	Saucer for Emma 14" Planter (Bag of 12)	3	2	1	1	2
AZ9913UXXTC	Saucer for Emma 16" Planter (Bag of 6)	6	4	2	2	4
AZ9915UXXTC	Saucer for Emma 18" Planter (Bag of 6)	6	4	2	2	4

Use below to order color preference:

	assortment code (includes display)	filler code	color selection	
Option 1	AZ1488U88JGK	AZ1488U88JGFK	1/3 Terracotta C+	2/3 Charcoal C+
Option 2	AZ1488U88IGK	AZ1488U88IGFK	2/3 Terracotta C+	1/3 Charcoal C+

B - SMALL DISPLAY

Emma Round Circular Positive Planters

(Terracotta and Charcoal)



Minimum Order for Free Display:
AZ20DISP1

product ref. #	product description	total bags	Option 1	
			charcoal	terracotta
	Small Display	1	-	-
AZ1408UXXC	Emma 8" Planter (Bag of 12)	4	2	2
AZ1410UXXC	Emma 10" Planter (Bag of 12)	4	2	2
AZ1412UXXC	Emma 12" Planter (Bag of 12)	4	2	2
AZ1414UXXC	Emma 14" Planter (Bag of 12)	4	2	2

Use below to order color preference:

	assortment code (includes display)	filler code	color selection	
Option 1	AZ1488U88HGK	AZ1488U88HGFK	1/2 Terracotta C+	1/2 Charcoal C+



10 YEAR WARRANTY PLANTERS



Longevity

Crescent Garden rotationally molded products provide a great value to consumers given their 10 year limited warranty.

Protecting Surfaces

We offer a variety of universal saucers, caddies and other solutions to protect surfaces indoors or outdoors.

Well Designed

Every planter is detailed to deliver durability, better gardening solutions, and versatility in color and style.

100% Recyclable

All our products are manufactured with polymer type ♻️ and can be recycled.

What makes our Planters Unique

Double Wall

To protect roots from extreme temperatures, select our double wall planters that have a pocket of air between roots and the external wall.

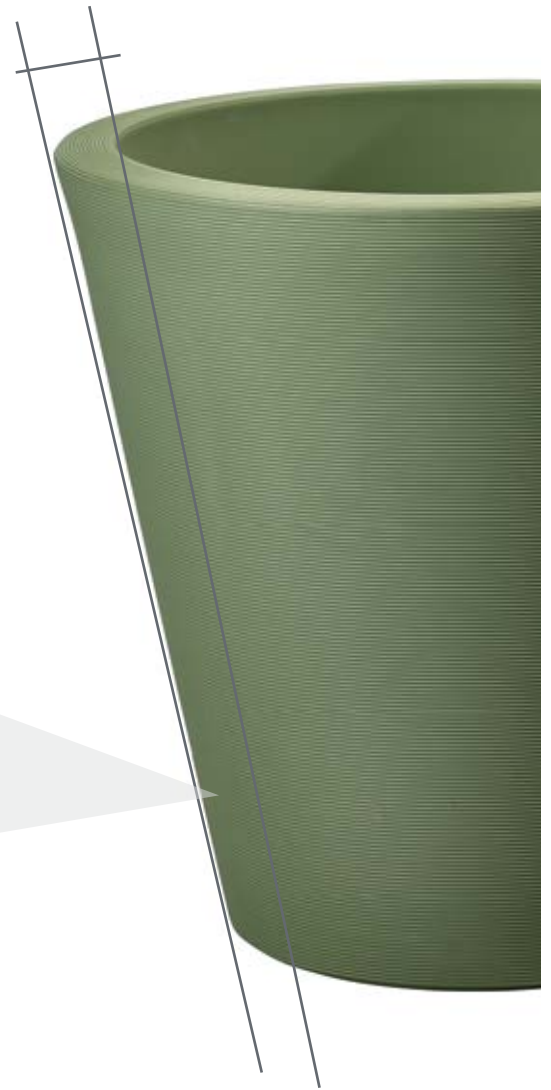

Lightweight

Our planters will make install a worry free process. We will make sure everything arrives to site intact and you won't need a large crew to get started.



10 Year Warranty

Our 10 Year Warranty against fading, or cracking will guarantee that you won't have complaints down the road.



Drainage

Healthy plants start with proper drainage. We design ours with elevated pot feet and drainage holes that are adequately sized for each planter.



Variety

Every style is available in stock in a curated selection of finishes, offering designers variety.
Want to mix it up and use a color we don't have in stock?

Contact us for your special orders.

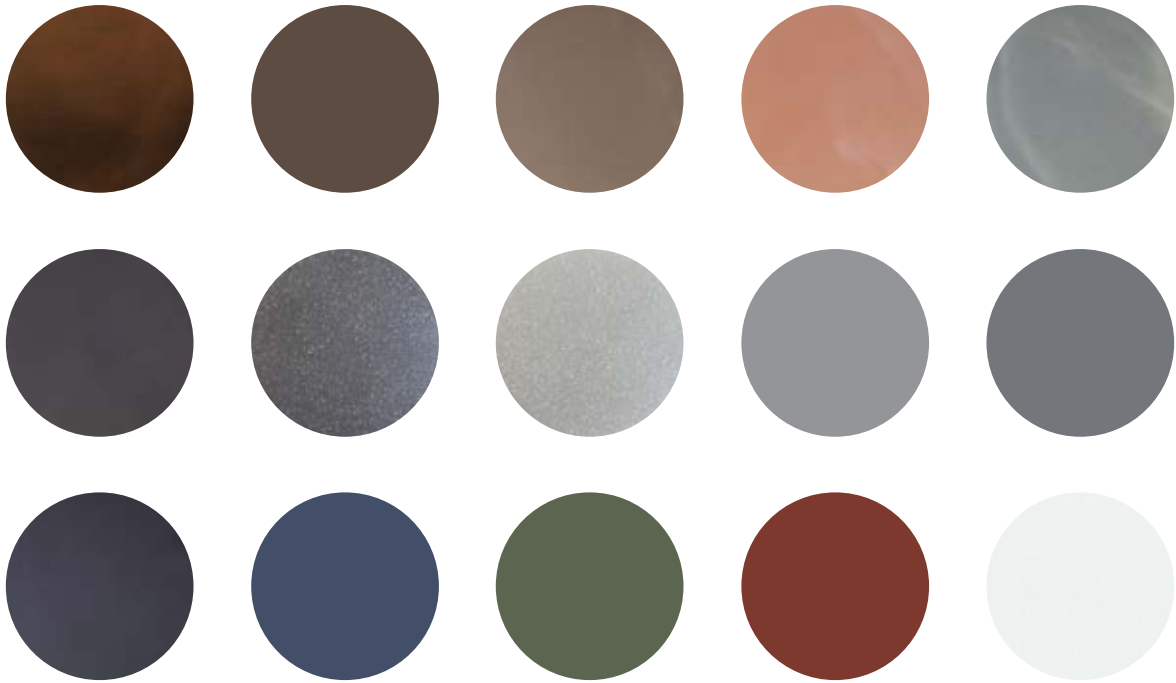

Bowls

Bowls have so many uses in a garden setting we wanted to make sure to provide you with a solution that works for all of those; our plugs allow you to easily change a bowl from a succulent garden, to a water garden or convert it into a bubbling fountain.



Use regular plug for water gardens.



Use plug with hole for fountains.



Use with no plug for planting.



Attainable Design

Many of our planters are designed with a single wall for a value oriented option that still has a 10 Yr Warranty.





Designing with Plants:
Carefully curated containers create a mini-garden
to soften hardscapes.



Young and Hip:
This step planter targets newbies who are looking for design.



Simplicity:
Adding green in narrow spaces is easily achieved with an oval shaped planter.

Crescent Garden: Design Ideas



Cityscapes:

Lightweight planters are ideal for rooftops and balconies where weight can be a concern.







Brunello Rolled-Rim Planters



Texture Detail



Caviar Black

		dimensions				volume capacity	planter ref.#	saucer ref.#
								
A	Brunello Rolled-Rim 12" Planter	11.40 in 29,0 cm	6.50 in 16,5 cm	9.68 in 24,6 cm	9.25 in 23,5 cm	2.25 gal 8,5 l	A2630XX	A9908XXT
B	Brunello Rolled-Rim 14" Planter	13.50 34,3	8.00 20,3	11.40 29,0	10.75 27,3	3.50 13,2	A2635XX	A9908XXT
C	Brunello Rolled-Rim 16" Planter	16.00 40,6	9.50 24,1	13.50 34,3	12.50 31,8	5.75 21,8	A2640XX	A9910XXT
D	Brunello Rolled-Rim 20" Planter	20.00 50,8	12.00 30,5	17.70 45,0	15.75 40,0	11.75 44,5	A2650XX	A9913XXT
E	Brunello Rolled-Rim 27" Planter	27.36 69,5	16.00 40,6	23.70 60,2	21.50 54,6	41.50 157,1	A2668XX	A9918XXT

10Year
Limited
Warranty

IN-STOCK QUICK SHIP COLORS



Caviar Black Ref: 94



Weathered Terracotta Ref: 34





Delano Planters





Texture Detail



Slate

		dimensions				volume capacity	planter ref.#	saucer ref.#
								
A	Delano 16" Planter	15.75 in 40,0 cm	7.00 in 17,8 cm	13.70 / 6.30 in 34,8 / 16,0 cm	7.80 in 19,8 cm	2.25 gal 8,5 l	A5340XX	A9908XXT
B	Delano 20" Planter	20.00 50,8	8.10 20,6	17.70 / 7.48 45,0 / 19,0	10.00 25,4	4.50 17,0	A5350XX	A9910XXT
C	Delano 26" Planter	26.00 66,0	10.50 26,7	23.70 / 9.84 60,2 / 25,0	13.00 33,0	10.75 40,7	A5366XX	A9913XXT
D	Delano 34" Planter*	33.70 85,6	13.70 34,8	31.70 / 13.78 80,5 / 35,0	17.00 43,2	24.00 90,8	A5386XX	A9915XXT

***Plug System Included for 34" Bowl**

		
Use regular plug for water gardens.	Use plug with hole for fountains.	Use with no plug for planting.



IN-STOCK QUICK SHIP COLORS



Slate Ref: 97







Midnight Ref: 55



Delano Oval Bowls

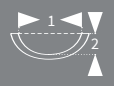

Texture Detail



		dimensions				volume capacity	planter ref.#
							
A	Delano Oval 24" Bowl	24.00 x 17.00 in 61,0 x 43,2 cm	14.10 x 10.00 in 35,8 x 25,4 cm	21.50 x 14.50 / 5.91 in 54,6 x 36,8 / 15,0 cm	8.00 in 20,3 cm	3.75 gal 14,2 l	A5460XX
B	Delano Oval 30" Bowl	30.00 x 21.10 76,2 x 53,6	16.30 x 11.60 41,4 x 29,5	27.40 x 18.70 / 7.28 69,6 x 47,5 / 18,5	10.00 25,4	7.75 29,3	A5476XX

Plug System Included		
		
Use regular plug for water gardens.	Use plug with hole for fountains.	Use with no plug for planting.



IN-STOCK QUICK SHIP COLORS



Slate Ref: 97







Midnight Ref: 55

Delano Tall Planters

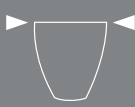

Texture Detail



		dimensions				volume capacity	planter ref.#	saucer ref.#
								
A	Delano Tall 16" Planter	16.00 in 40,6 cm	7.10 in 18,0 cm	13.10 / 12.20 in 33,3 / 31,0 cm	17.60 in 44,7 cm	4.50 gal 17,0 l	A5540XX	A9908XXT



IN-STOCK QUICK SHIP COLORS



Slate Ref: 97



Midnight Ref: 55

Eye Planters



Cloud White









Eye Planters



Texture Detail



Cloud White

A		dimensions				volume capacity	planter ref.#
							
A	Eye Am 26" Planter	26.00 66,0	21.00 53,3	21.90 x 14.50 / 22.76 55,6 x 36,8 / 57,8	24.60 62,5	13.00 49,2	A7866XX



IN-STOCK QUICK SHIP COLORS



Caviar Black Ref: 94



Cloud White Ref: 00



Midnight Ref: 55



Olive Ref: 82

Fold Planters







NOW
Sold Individually



Texture Detail



Bedrock Circular+

		dimensions						volume capacity		planter ref.#
										
A	Fold 15" Planter (Small)	14.96 38,0	in cm	9.37 23,8	in cm	13.58 34,5	in cm	6.08 23,0	gal l	B09015MXXX
B	Fold 18" Planter (Medium)	18.11 46,0		9.45 24,0		16.69 42,4		10.88 41,2		B09018MXXX
C	Fold 22" Planter (Large)	22.05 56,0		13.39 34,0		19.88 50,5		19.55 74,0		B09022MXXX

Add TruDrop Flex insert for self-watering alternative. Page 83



IN-STOCK QUICK SHIP COLORS



Autumn Circular + Ref: U33



Bedrock Circular Ref: U93



Juniper Circular + Ref: U60



Coal Circular + Ref: U94

...wants
...I want
...the rare yarbubir julung, a bollyn is dearest fit
...re mullory Molly are the big ideas mullion
...Turkey the favourite game off the always d
...he a beautifyn Torrenfino is very you interest
...memory called the memo super it million
...favourite. You don't na a famous people
...y called kind girl somebody went many
...you sorry for my Endun, some
...ful, colored don't coffe as m
...ful, colored don't coffe as m
...somebody
...somebody
...feeling it
...to go. A
...memorie
...Somebody
...nation celore







Madison Planters



Texture Detail



Slate

		dimensions				volume capacity	planter ref.#	saucer ref.#
								
A	Madison 16" Planter	16.00 in 40,6 cm	10.03 in 25,5 cm	13.60 / 12.48 in 34,5 / 31,7 cm	16.00 in 40,6 cm	5.09 gal 19,3 l	A1140XXA	A9910XXT
B	Madison 20" Planter	20.00 50,8	12.28 31,2	17.46 / 15.61 44,3 / 39,6	20.00 50,8	10.71 40,5	A1150XXA	A9913XXT
C	Madison 26" Planter	26.00 66,0	16.04 40,7	22.21 / 18.24 56,4 / 46,3	26.00 66,0	20.85 78,9	A1165XXA	A9918XXT
D	Madison 34" Planter	34.00 86,4	21.04 53,4	29.39 / 23.67 74,7 / 60,1	34.00 86,4	48.59 183,9	A1180XXA	A9990XXT



IN-STOCK QUICK SHIP COLORS



Caviar Black Ref: 94



Cloud White Ref: 00



Weathered Terracotta Ref: 34



Slate Ref: 97



Olive Ref: 82











Origami Planters



Texture Detail

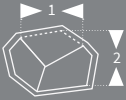

Cloud White

		dimensions						volume capacity	planter ref.#
									
A	Origami 23" Planter	23.00 in 58,4 cm	23.00 in 58,4 cm	13.50 x 12.50 / 10.05 in 34,3 x 31,8 / 25,5 cm	14.50 in 36,8 cm	6.50 gal 24,6 l	A5658XX		
B	Origami 26" Tall Planter	25.75 65,4	25.75 65,4	17.00 x 16.00 / 17.80 43,2 x 40,6 / 45,2	25.00 63,5	13.50 51,1	A5766XX		



IN-STOCK QUICK SHIP COLORS



Caviar Black Ref: 94



Cloud White Ref: 00

Pleat Planters







**ROOFTOP BAR
NOW OPEN**

39







Pleat Planters

Texture Detail

Olive



		dimensions				volume capacity	planter ref.#	saucer ref.#
								
A	Pleat 15" Planter	15.00 in 38,1 cm	7.48 in 19,0 cm	14.45 in 36,7 cm	15.00 in 38,1 cm	7.40 gal 28,0 l	A6638XX	A9908XXT
B	Pleat 19" Planter	19.00 48,3	9.25 23,5	18.43 46,8	19.00 48,3	14.53 55,0	A6648XX	A9910XXT
C	Pleat 23" Planter	23.00 58,4	11.42 29,0	22.01 55,9	23.00 58,4	26.81 101,5	A6658XX	A9913XXT
D	Pleat Tall 23" Planter	23.00 58,4	11.42 29,0	22.01 55,9	27.00 68,6	32.10 121,5	A6659XX	A9913XXT
E	Pleat 27" Planter	27.00 68,6	14.17 36,0	26.42 67,1	27.00 68,6	46.23 175,0	A6668XX	A9915XXT
F	Pleat Tall 27" Planter	27.00 68,6	14.17 36,0	26.42 67,1	32.00 81,3	54.95 208,0	A6669XX	A9915XXT

10Year
Limited
Warranty

IN-STOCK QUICK SHIP COLORS



Caviar Black Ref: 94



Cloud White Ref: 00



Slate Ref: 97



Midnight Ref: 55



Olive Ref: 82

Ridge Planters





NOW
Sold Individually



Texture Detail



Autumn Circular+

		dimensions						volume capacity	planter ref.#	
										
A	Ridge 15" Planter (Small)	14.96 38,0	in cm	8.86 22,5	in cm	13.58 34,5	in cm	5.55 21,0	gal l	B08815MXXX
B	Ridge 18" Planter (Medium)	18.11 46,0		9.45 24,0		16.69 42,4		10.30 39,0		B08818MXXX
C	Ridge 22" Planter (Large)	22.05 56,0		12.52 31,8		19.88 50,5		18.49 70,0		B08822MXXX

Add TruDrop Flex insert for self-watering alternative. Page 83

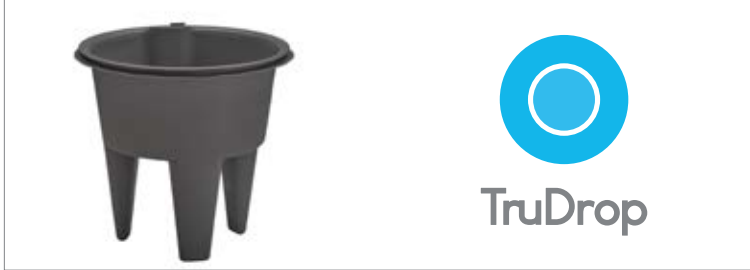

IN-STOCK QUICK SHIP COLORS



Autumn Circular + Ref: U33



Bedrock Circular Ref: U93



Juniper Circular + Ref: U60



Coal Circular + Ref: U94

Step Planters





NOW
Sold Individually



Texture Detail



Bedrock Circular+

		dimensions						volume capacity	planter ref.#	
										
A	Step 15" Planter (Small)	14.96 38,0	in cm	8.86 22,5	in cm	13.58 34,5	in cm	6.08 23,0	gal l	B08915MXXX
B	Step 18" Planter (Medium)	18.11 46,0		9.45 24,0		16.69 42,4		11.10 42,0		B08918MXXX
C	Step 22" Planter (Large)	22.05 56,0		12.87 32,7		19.88 50,5		19.81 75,0		B08922MXXX

Add TruDrop Flex insert for self-watering alternative. Page 83



TruDrop



IN-STOCK QUICK SHIP COLORS



Autumn Circular + Ref: U33



Bedrock Circular Ref: U93



Juniper Circular + Ref: U60



Coal Circular + Ref: U94



MOBILITY AND DRAINAGE SOLUTIONS

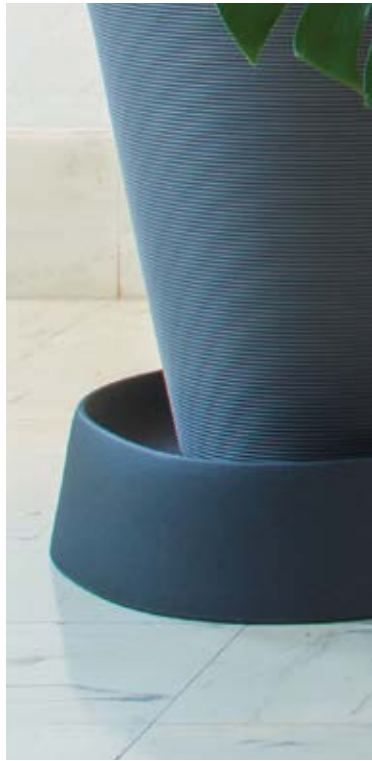

Successful Gardening

We know drainage is essential to healthy plants, but protecting surfaces is also important so we offer a variety of solutions to make it happen.

Innovative Solutions

Maintaining proper drainage is indispensable for the survival of containerized plants. Our accessories present a variety of innovative solutions.

Movable Planters

Once potted large planters can be heavy. Add mobility to some of our planters with our casters, to clean and transform spaces easily.

In-Store displays

These accessories are easy to merchandise with our ready to go display racks. We offer a variety of display options always considering smaller footprints and great visual appeal.

Pebble Plant Caddies







These planters can move:
Hidden casters make it easy to clean or move
your plants as the seasons change.



Pebble Plant Caddies



		dimensions				product ref.#
						
A	Pebble Small Plant Caddy	15.91 x 15.04 40,4 x 38,2	in cm	4.37 11,1	in cm	A8040XXR
B	Pebble Medium Plant Caddy	19.45 x 17.09 49,4 x 43,4		3.98 10,1		A8050XXR
C	Pebble Large Plant Caddy	23.39 x 19.69 59,4 x 50,0		3.58 9,1		A8060XXR

Caddies can easily support 200 pounds.



10Year*
Limited
Warranty

IN-STOCK QUICK SHIP COLORS



Caviar Black Ref: 94



Cloud White Ref: 00



Ash Ref: 98



Slate Ref: 97



Midnight Ref: 55



Olive Ref: 82



Currant Ref: 47

* 10 Year Limited Warranty for indoor use.

Pebble Large Plant Caddy Display



Pebble Large Plant Caddy Display

Minimum order for **free display**

product ref.#	description	qty
A80888RXK	Display for Pebble Plant Caddies	
A8040XXR	Pebble Small Plant Caddy	8 Caddies
A8050XXR	Pebble Medium Plant Caddy	6 Caddies
A8060XXR	Pebble Large Plant Caddy	4 Caddies

Use below to order color preference:





assortment code	color selection	
A80888REK	 Black	 White
A80888RFK	 Black	 Ash
A80888RGK	 Black	 Currant
A80888RHK	 White	 Midnight
A80888RIK	 Olive	 Bark
A80888RJK	 Slate	 Currant

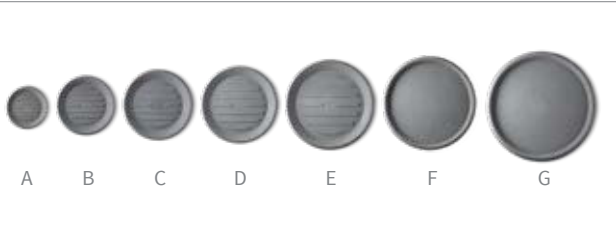

PLEASE NOTE: Displays are available only for use with Crescent Garden product.

Universal Round Saucers



		dimensions						product ref.#
								
A	8" Circular Universal Saucer	11.00 27,9	in cm	1.00 2,5	in cm	8.50 21,6	in cm	A9908XXT
B	11" Circular Universal Saucer	15.00 38,1		1.50 3,8		11.00 27,9		A9910XXT
C	13" Circular Universal Saucer	18.00 45,7		2.00 5,1		13.25 33,7		A9913XXT
D	15" Circular Universal Saucer	20.00 50,8		2.00 5,1		15.50 39,4		A9915XXT
E	18" Circular Universal Saucer	23.50 59,7		2.50 6,4		18.50 47,0		A9918XXT
F	19.7" Circular Universal Saucer	22.00 55,9		2.38 6,0		19.75 50,2		A9985XXT
G	22.8" Circular Universal Saucer	25.50 64,8		2.38 6,0		23.00 58,4		A9990XXT
H	NEW Assorted Bundle Pack of Universal Saucers (Caviar Black or Weathered Terracotta) Includes: 20 ea of 8", 11" & 13", and 10 ea of 15" & 18"							A9988XXT





10Year
Limited
Warranty

IN-STOCK QUICK SHIP COLORS

			8" Saucer	11" Saucer	13" Saucer	15" Saucer	18" Saucer	19.7" Saucer	22.8" Saucer
	Ref: 00	Cloud White	✓	✓	✓	✓	✓	✓	✓
	Ref: 92	Weathered Concrete	✓	✓	✓	✓	✓	✓	✓
	Ref: 98	Ash	✓	✓	✓	✓	✓	✓	✓
	Ref: 97	Slate	✓	✓	✓	✓	✓	✓	✓
	Ref: 14	Old Bronze	✓	✓	✓	✓	✓	✓	✓
	Ref: 94	Caviar Black	✓	✓	✓	✓	✓	✓	✓
	Ref: 33	Rust	✓	✓	✓	✓	✓	✓	✓
	Ref: 74	Bark	✓	✓	✓	✓	✓		✓
	Ref: 44	Mocha	✓	✓	✓	✓	✓	✓	✓
	Ref: 34	Weathered Terracotta	✓	✓	✓	✓	✓	✓	✓
	Ref: 11	Parchment	✓	✓	✓	✓	✓	✓	✓
	Ref: 82	Olive	✓	✓	✓	✓	✓		✓
	Ref: 55	Midnight	✓	✓	✓	✓	✓		✓
	Ref: 55	Shadow							

Universal Square Saucers



		dimensions						product ref.#
								
A	9" Square Universal Saucer	12.50 x 12.50 31,8 x 31,8	in cm	1.00 2,5	in cm	9.00 x 9.00 22,9 x 22,9	in cm	A9822XXT
B	11" Square Universal Saucer	14.50 x 14.50 36,8 x 36,8		1.25 3,2		11.20 x 11.20 28,4 x 28,4		A9827XXT
C	13" Square Universal Saucer	16.75 x 16.75 42,5 x 42,5		1.25 3,2		13.25 x 13.25 33,7 x 33,7		A9832XXT
D	16" Square Universal Saucer	19.75 x 19.75 50,2 x 50,2		1.50 3,8		16.25 x 16.25 41,3 x 41,3		A9841XXT
E	NEW Assorted Bundle Pack of Square Saucers (Caviar Black or Weathered Terracotta) Includes: 20 ea of 9" & 11" and 10 ea of 13" & 16"							A9888XXT

10Year
Limited
Warranty

IN-STOCK QUICK SHIP COLORS

		9" Saucer	11" Saucer	13" Saucer	16" Saucer
	Ref: 00 Cloud White	✓	✓	✓	✓
	Ref: 92 Weathered Concrete	✓	✓	✓	✓
	Ref: 98 Ash	✓	✓	✓	✓
	Ref: 97 Slate	✓	✓	✓	✓
	Ref: 14 Old Bronze	✓	✓	✓	✓
	Ref: 94 Caviar Black	✓	✓	✓	✓
	Ref: 33 Rust	✓	✓	✓	✓
	Ref: 74 Bark				
	Ref: 44 Mocha	✓	✓	✓	✓
	Ref: 34 Weathered Terracotta	✓	✓	✓	✓
	Ref: 11 Parchment	✓	✓	✓	✓
	Ref: 82 Olive				
	Ref: 55 Midnight				
	Ref: 55 Shadow				

Universal Round Saucer Display

Minimum order for **free display**

product ref.#	Saucer description: any color combination can be selected	qty
A9908XXT	8" Circular Universal Saucer	20
A9910XXT	11" Circular Universal Saucer	20
A9913XXT	13" Circular Universal Saucer	20
A9915XXT	15" Circular Universal Saucer	10
A9918XXT	18" Circular Universal Saucer	10
A99DISP1	Display Unit for Circular Saucer includes baskets and signage	1

Our in store displays are designed to show at **eye level** unlike traditional saucer displays that are short.



PLEASE NOTE: Displays are available only for use with Crescent Garden or Dotchi branded product.

Universal Square Saucer Display

Minimum order for **free display**

product ref.#	Saucer description: any color combination can be selected	qty
A9822XXT	9" Square Universal Saucer	20
A9827XXT	11" Square Universal Saucer	20
A9832XXT	13" Square Universal Saucer	10
A9841XXT	16" Square Universal Saucer	10
A98DISP1	Display Unit for Square Saucer includes baskets and signage	1

Our in store displays are designed to show at **eye level** unlike traditional saucer displays that are short.

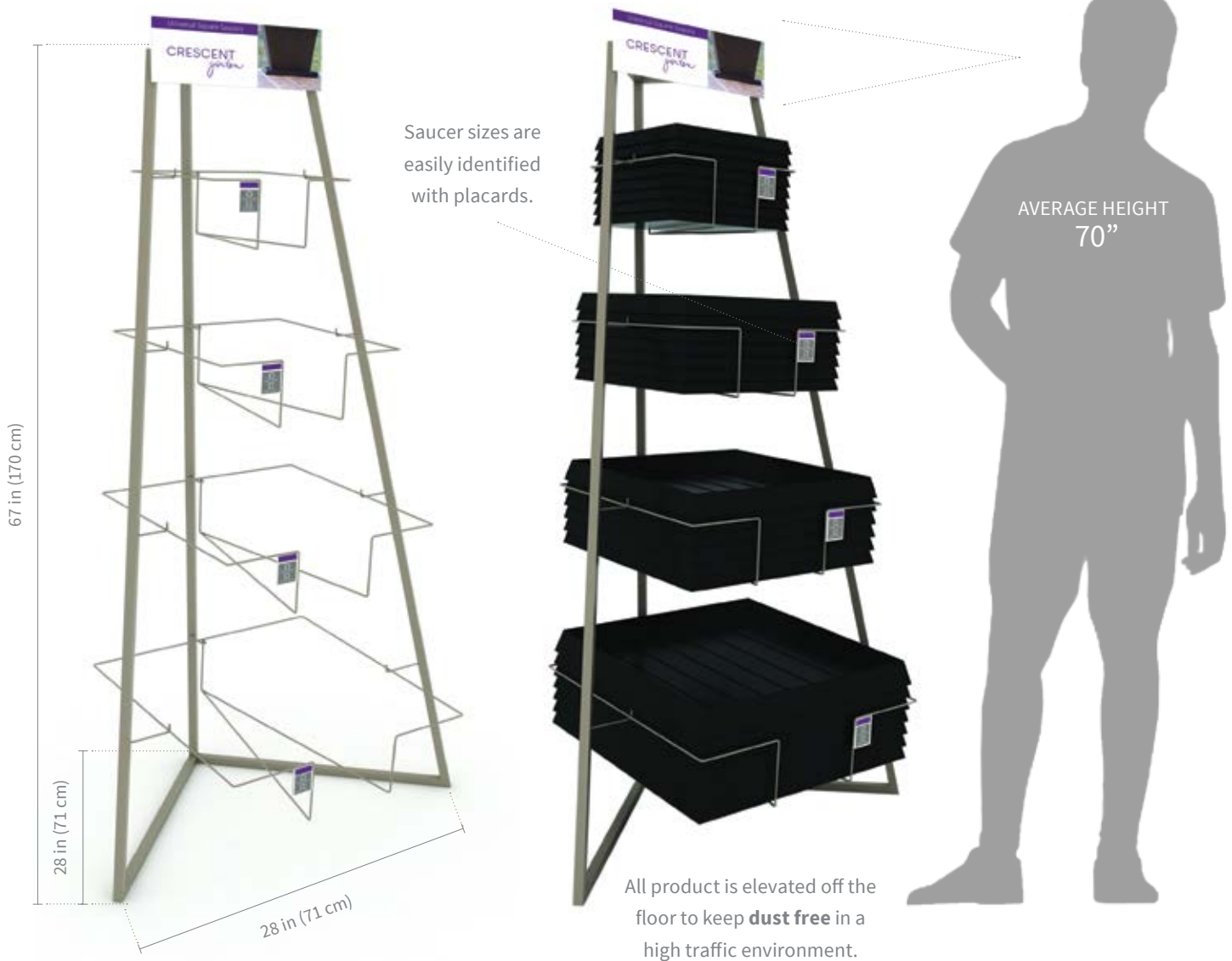

PLEASE NOTE: Displays are available only for use with Crescent Garden or Dotchi branded product.



MARKETING AIDS



Great Visual Aids

We want to provide you with the tools to communicate our product attributes better. When a sales attendant is not close to your customer our banners and product platforms help communicate our product warranty, and inspire your customers.

Digital Marketing

In a digital age we realize it is important for us to provide you not only with in store visual aids but also digital content. We want you to take advantage of all our brand awareness marketing.

Creating a Home for Crescent Garden Products

Through advertising in magazines, product releases and web campaigns we promote the Crescent brands. We want the customer to make the connection inside your store.

Premier Garden Center Program

Our Premier Garden Center program gets you started with free point of purchase aids, specialized Lunch and Learn opportunities for your employees and much more. Ask your sales representative for more information on how to become a premier dealer.

In Store Videos

Request copies of our video content to run in your video displays in store. From TruDrop videos to our 360 degree sprayers we are continuously adding to our library. Make sure we provide you with the latest content.



Social Media Sharing

12 months a year we are working at promoting Crescent Garden brand awareness on our social media channel. Be sure to follow us so you can see the latest content, and share with your consumers when it is relevant to your own marketing efforts.



Event Promotions

Use our consumer network. If you have an event in your garden center related to container gardening or Crescent Garden products, be sure to let us know. We would love to share news on our social media.





Be a part of our Content

Would like to be a greater part of our content. Be sure to tag us when posting pictures with our products. Reach out to us to participate in Crescent Garden events. We invite experts like yourselves all the time into our channel.



Garden Center Signage and Color Sample Pack

		dimensions		Product ref.#	
					
A	Branded Pinch Planter 29 inch for Premier Dealer	28.98 73,6	in cm	26.06 66,2 in cm	A6774XX-1000001
B	NEW Crescent Color Sample Set: Includes current color disks in every color	3.50 8,9		5.25 13,3	A83CG25

A

- Available for qualified customers.
- **For details please consult with your representative.**



B



IN-STOCK QUICK SHIP COLORS



Caviar Black
Ref: 94



Cloud White
Ref: 00



Ash
Ref: 98



Slate
Ref: 97



Midnight
Ref: 55





Olive
Ref: 82

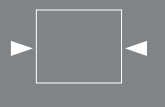
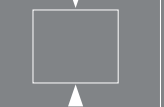

Bark
Ref: 74

Crescent Garden Display Platforms

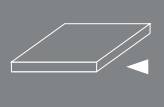
		dimensions			Product ref.#
					
A	Crescent Garden European Pallet Cover Display 100 x 120 cm (2pk)	47.24 in 120,0 cm	39.37 in 100,0 cm	5.00 in 12,7 cm	APOP36
B	Crescent Garden European Pallet Cover Display 120 x 80 cm (2pk)	47.24 in 120,0 cm	31.50 in 80,0 cm	5.00 in 12,7 cm	APOP37

Easy Three Step Process:



1. Use one regular european standard Pallet



2. Lay our sleeves on top and fold flaps down

READY TO SELL!



3. Place your Crescent Garden Planters on top

TruDrop Multilingual POP Material

		dimensions					

Flexible Banners

A	Crescent Garden Banner We Help You Grow	3.00 91,4	ft cm	2.00 61,0	ft cm	APOP27	Multilingual*
B	TruDrop One Go Weeks Diagram Rim Planter (Mom and Son Gardening)	3.00 91,4	ft cm	2.00 61,0	ft cm	APOP26	Multilingual*
C	TruDrop One Go Weeks Diagram for Banner Stand Dot Planter (Morning Break)	3.00 91,4	ft cm	2.00 61,0	ft cm	APOP28	Multilingual*
D	TruDrop One Go Weeks Diagram Cup Planter (Reading a Book)	3.00 91,4	ft cm	2.00 61,0	ft cm	APOP29	Multilingual*
E	TruDrop One Go Weeks Diagram Nest Planter (Balcony Reading a Book)	3.00 91,4	ft cm	2.00 61,0	ft cm	APOP30	Multilingual*

* Multilingual POP (English, Dutch, French, German, Spanish)

A



B



C



D



E



		dimensions					
		▶ ◀		◀ ▶			

Coroplast rigid banner (Works with Banner Stand)

F	Crescent Garden Banner We Help You Grow NEW	3.00 91,4	ft cm	2.00 61,0	ft cm	APOP27C	Multilingual*
G	TruDrop One Go Weeks Diagram for Banner Stand Rim Planter (Mom and Son Gardening)	3.00 91,4	ft cm	2.00 61,0	ft cm	APOP26CDE APOP26CEN APOP26CFR	German UK English French
H	TruDrop One Go Weeks Diagram for Banner Stand Cup Planter (Reading a Book)	3.00 91,4	ft cm	2.00 61,0	ft cm	APOP29CDE APOP29CEN APOP29CFR	German UK English French
I	TruDrop One Go Weeks Diagram for Banner Stand Nest Planter (Balcony Reading a Book)	3.00 91,4	ft cm	2.00 61,0	ft cm	APOP30CDE APOP30CEN APOP30CFR	German UK English French
J	TruDrop Flex for Banner Stand	3.00 91,4	ft cm	2.00 61,0	ft cm	APOP38CDE	German
K	Stand for TruDrop Banners (holds 2 back to back)	N/A		72.00 182,9	in cm	APOP23	N/A

F



Multilingual

G



German, UK English or French

H



German, UK English or French

I



German, UK English or French

J



German

K





we help you grow

CELEBRATING
25 YEARS

 +1 (305) 477-0024

www.crescentgarden.com

VERSION 0924